

# MSM600GS33ALT

SiC MOSFET 3300V

**FEATURES**

- \* Ultra low switching loss with SiC MOSFET
- \* High current density package
- \* Low stray inductance & low Rth(j-c)
- \* Half-bridge (2in1)
- \* Built in temperature sensor
- \* Scalable large current easily handled by paralleling
- \* Equipped with current sensing terminals
- \* Sintered copper bonding technology
- \* SBD-less SiC module

**ABSOLUTE MAXIMUM RATINGS (T<sub>C</sub>=25°C )**

Item	Symbol	Unit	MSM600GS33ALT
Drain Source Voltage	V <sub>DSS</sub>	V	3,300
Gate Source Voltage	V <sub>GSS</sub>	V	+20/-15
Drain Current	DC	I <sub>D</sub>	600
	1ms	I <sub>DM</sub>	1,200
Source Current	DC	I <sub>S</sub>	600
	1ms	I <sub>SM</sub>	1,200
Junction Temperature	T <sub>vj op</sub>	°C	-50 ~ +175
Storage Temperature	T <sub>stg</sub>	°C	-55 ~ +150
Isolation Voltage	V <sub>ISO</sub>	V <sub>RMS</sub>	6,000(AC 1 minute)
Screw Torque	Terminals (M3/M8)	M	0.8/15
	Mounting (M6)	M	6.0 (1)

Notes: (1) Recommended Value 5.5±0.5N·m

**ELECTRICAL CHARACTERISTICS**

Item	Symbol	Unit	Min.	Typ.	Max.	Test Conditions	
Drain Source Cut-Off Current	I <sub>DSS</sub>	mA	-	-	0.05	V <sub>DS</sub> =3,300V, V <sub>GS</sub> =0V, T <sub>vj</sub> =25°C	
			-	-	1	V <sub>DS</sub> =3,300V, V <sub>GS</sub> =0V, T <sub>vj</sub> =175°C	
Gate Source Leakage Current	I <sub>GSS</sub>	nA	-	-	+100	V <sub>GS</sub> =20V, V <sub>DS</sub> =0V, T <sub>vj</sub> =25°C	
			-100	-	-	V <sub>GS</sub> =-15V, V <sub>DS</sub> =0V, T <sub>vj</sub> =25°C	
Drain Source on-state Voltage	V <sub>DS(on)</sub>	V	-	2.3	-	I <sub>D</sub> =600A, V <sub>GS</sub> =15V, T <sub>vj</sub> =25°C	
			-	4.2	5.5	I <sub>D</sub> =600A, V <sub>GS</sub> =15V, T <sub>vj</sub> =175°C	
Gate Source Threshold Voltage	V <sub>GS(th)</sub>	V	2.2	3.0	3.8	V <sub>DS</sub> =10V, I <sub>D</sub> =600mA, T <sub>vj</sub> =25°C	
Input Capacitance	C <sub>iss</sub>	nF	-	173	-	V <sub>DS</sub> =10V, V <sub>GS</sub> =0V, f=100kHz, T <sub>vj</sub> =25°C	
Internal Gate Resistance	R <sub>G(int)</sub>	Ω	-	2.4	-		
Turn On Delay Time	t <sub>d(on)</sub>	μs	-	1.3	-	V <sub>DD</sub> =1,800V, I <sub>D</sub> =600A L <sub>S</sub> =40nH, R <sub>G(ON/OFF)</sub> =1.5/2.2Ω (2) V <sub>GS</sub> =+15/-10V, T <sub>vj</sub> =175°C	
Rise Time	t <sub>r</sub>		-	0.4	-		
Turn Off Delay Time	t <sub>d(off)</sub>		-	1.5	-		
Fall Time	t <sub>f</sub>		-	0.25	-		
Source Drain Voltage	V <sub>SD</sub>	V	-	1.7	-	I <sub>S</sub> =600A, V <sub>GS</sub> =15V, T <sub>vj</sub> =25°C	
			-	3.8	5	I <sub>S</sub> =600A, V <sub>GS</sub> =15V, T <sub>vj</sub> =175°C	
			-	8.2	-	I <sub>S</sub> =600A, V <sub>GS</sub> =-10V, T <sub>vj</sub> =25°C	
			-	6.4	-	I <sub>S</sub> =600A, V <sub>GS</sub> =-10V, T <sub>vj</sub> =175°C	
Reverse Recovery Time	t <sub>rr</sub>	μs	-	0.65	-	V <sub>DD</sub> =1,800V, I <sub>S</sub> =600A, L <sub>S</sub> =40nH, R <sub>G(ON/OFF)</sub> =1.5/2.2Ω, T <sub>vj</sub> =175°C	
Turn On Loss	E <sub>on</sub>	J/P	-	0.7	-	V <sub>DD</sub> =1,800V, I <sub>D</sub> =600A, L <sub>S</sub> =40nH, R <sub>G(ON/OFF)</sub> =1.5/2.2Ω (2)	
Turn Off Loss	E <sub>off</sub>	J/P	-	0.3	-		
Reverse Recovery Loss	E <sub>rr</sub>	J/P	-	0.04	-	V <sub>GS</sub> =+15V/-10V, T <sub>vj</sub> =175°C	
Stray inductance module	L <sub>SCE</sub>	nH	-	10	-	Between D1 (main) and S2(main)	
NTC-Thermistor	Resistance	R <sub>25</sub>	kΩ	-	5	-	T <sub>C</sub> =25°C
	Deviation	ΔR/R	%	-5	-	5	T <sub>C</sub> =25°C
	B-constant	B <sub>(25/50)</sub>	K	-	3375	-	Between 25°C and 50°C
Thermal Impedance	MOS	R <sub>th(j-c)</sub>	K/W	-	-	0.033	Junction to case
Contact Thermal Impedance		R <sub>th(c-f)</sub>	K/W	-	0.02	-	Case to fin(par 1 arm)

Notes: (2) R<sub>G</sub> value is a test condition value for evaluation, not recommended value.

Please determine the suitable R<sub>G</sub> value by measuring switching behavior and checking results with the respective SOA.

- \* Please contact our representatives at order.
- \* For improvement, specifications are subject to change without notice.
- \* For actual application, please confirm this spec sheet is the newest revision.
- \* ELECTRICAL CHARACTERISTIC items shown in above table are according to IEC 60747-2 and IEC 60747-9.

# MSM600GS33ALT

OUTLINE DRAWING

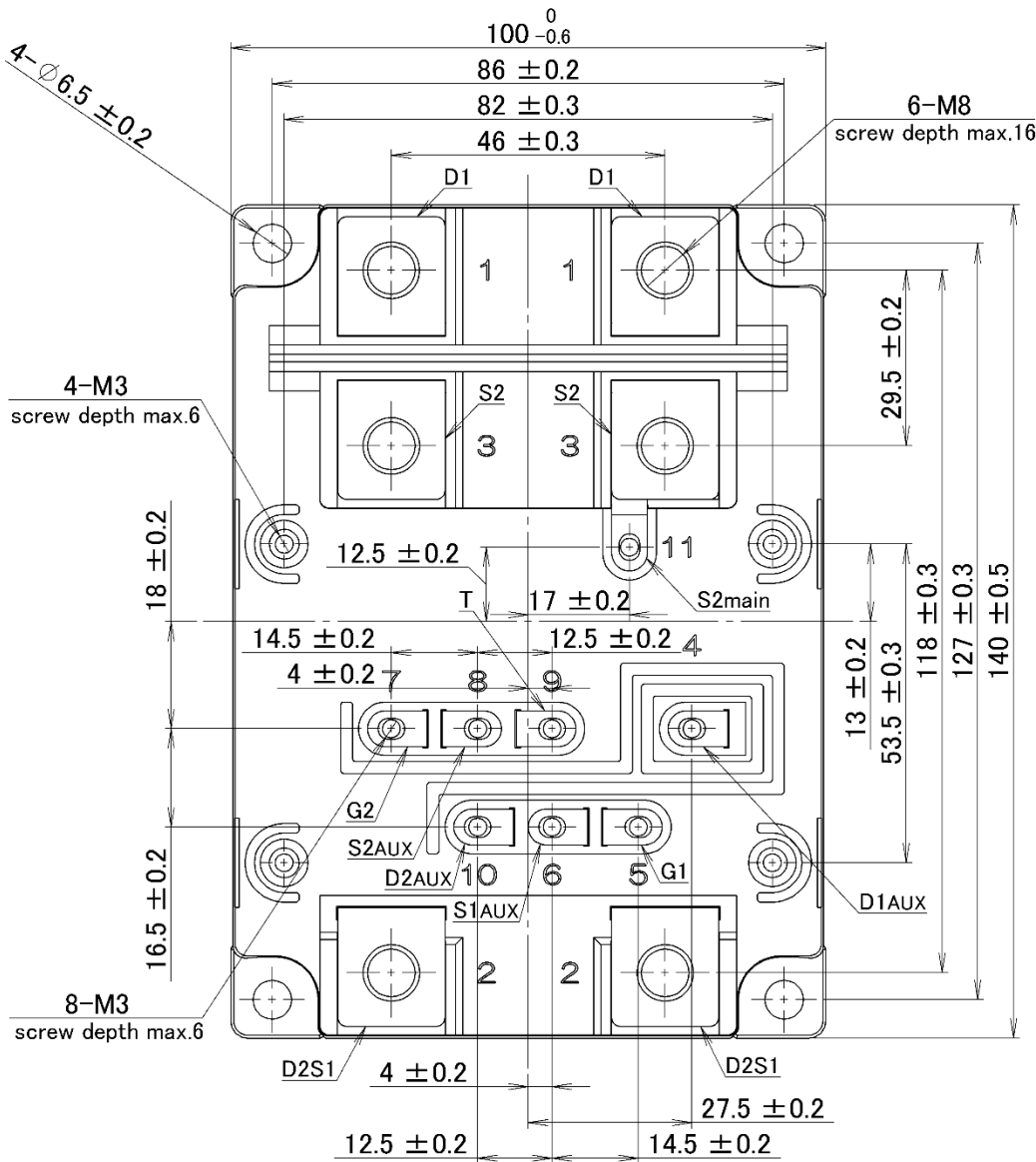

Unit in mm

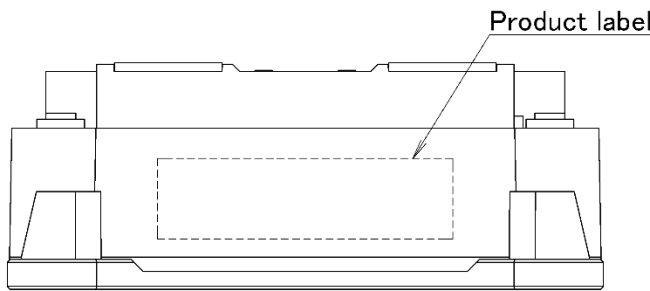
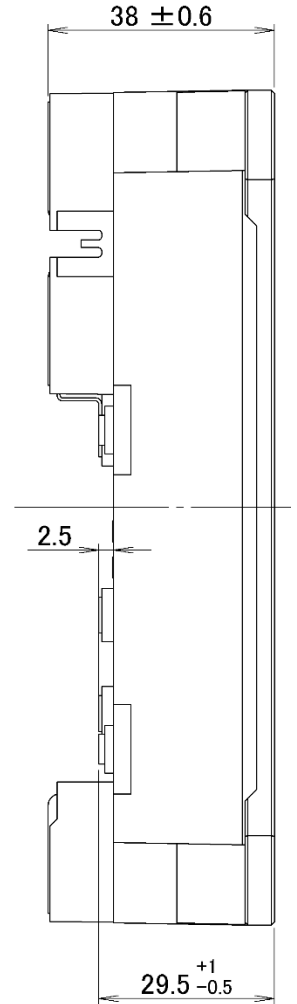

Weight: 770(g)

- 1 : D1
- 2 : D2S1
- 3 : S2
- 4 : D1AUX
- 5 : G1
- 6 : S1AUX
- 7 : G2
- 8 : S2AUX
- 9 : T
- 10 : D2AUX
- 11 : S2main

Terminal Number

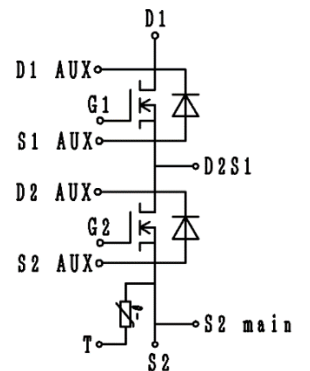

Circuit Diagram

# MSM600GS33ALT

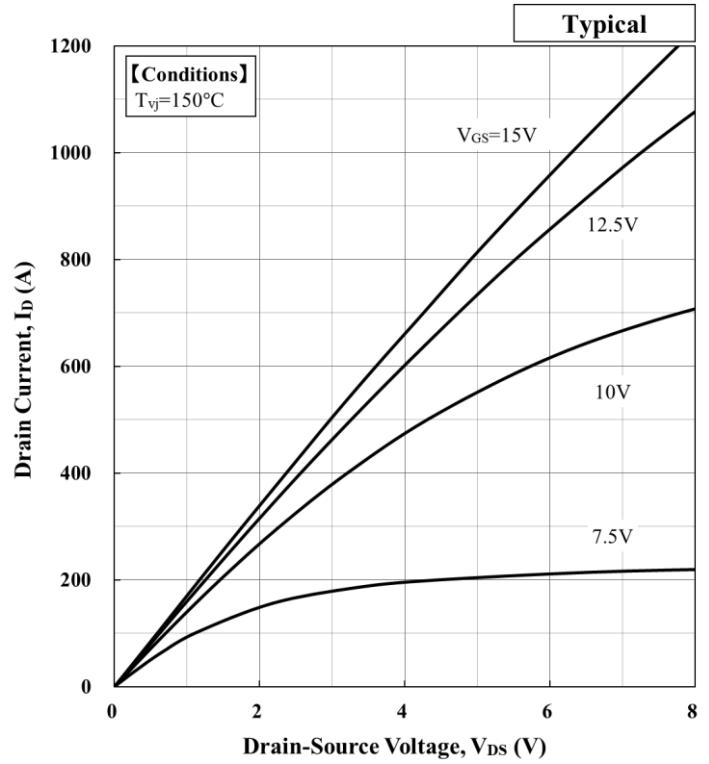
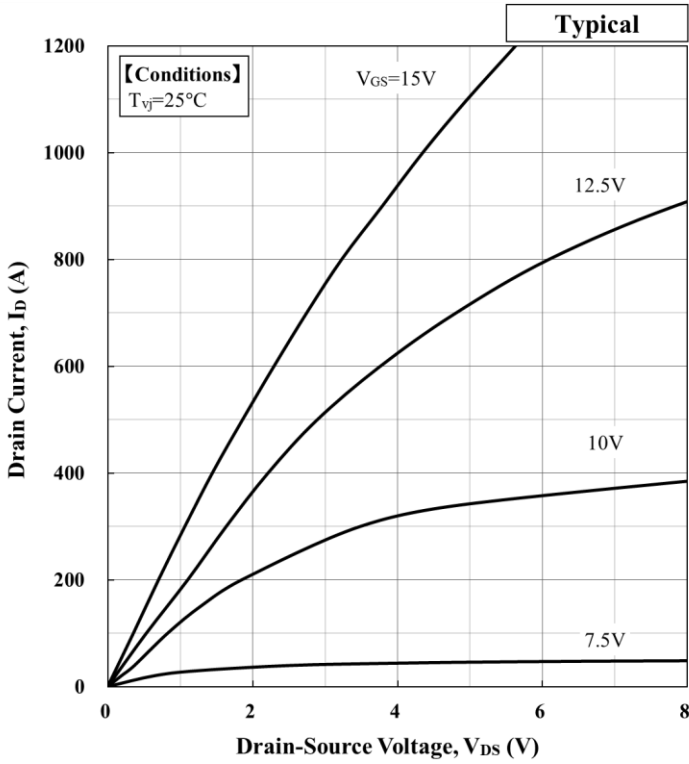

$$V_{DS}[V] = a_3 \cdot |I_D|^3 + a_2 \cdot |I_D|^2 + a_1 \cdot |I_D| + a_0$$

Temp. [°C]	V <sub>GS</sub> [V]	a <sub>3</sub>	a <sub>2</sub>	a <sub>1</sub>	a <sub>0</sub>
25	15	5.89E-10	4.31E-07	3.32E-03	1.75E-02

$$V_{DS}[V] = a_3 \cdot |I_D|^3 + a_2 \cdot |I_D|^2 + a_1 \cdot |I_D| + a_0$$

Temp. [°C]	V <sub>GS</sub> [V]	a <sub>3</sub>	a <sub>2</sub>	a <sub>1</sub>	a <sub>0</sub>
150	15	2.72E-10	2.99E-07	5.71E-03	1.61E-02

Drain Current vs. Drain - Source Voltage

Drain Current vs. Drain - Source Voltage

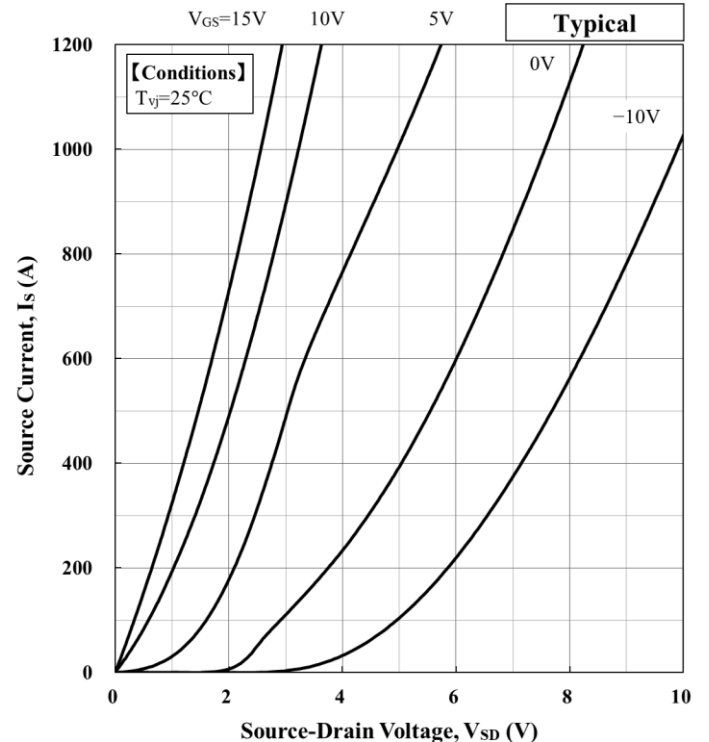
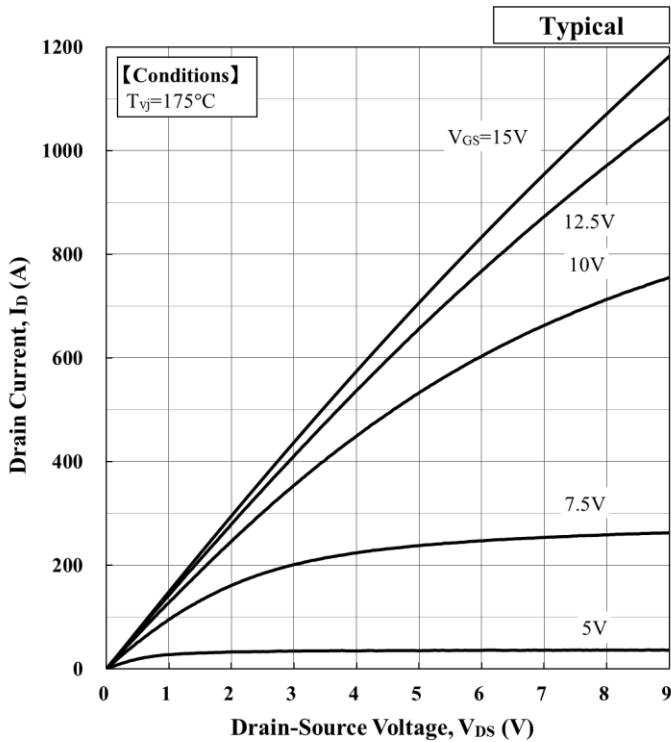

$$V_{DS}[V] = a_3 \cdot |I_D|^3 + a_2 \cdot |I_D|^2 + a_1 \cdot |I_D| + a_0$$

Temp. [°C]	V <sub>GS</sub> [V]	a <sub>3</sub>	a <sub>2</sub>	a <sub>1</sub>	a <sub>0</sub>
175	15	4.21E-10	3.41E-07	6.63E-03	5.43E-03

$$V_{SD}[V] = a_3 \cdot |I_S|^3 + a_2 \cdot |I_S|^2 + a_1 \cdot |I_S| + a_0$$

Temp. [°C]	V <sub>GS</sub> [V]	a <sub>3</sub>	a <sub>2</sub>	a <sub>1</sub>	a <sub>0</sub>
25	15	2.46E-10	-1.09E-06	3.41E-03	1.09E-04

Drain Current vs. Drain - Source Voltage

Source Current vs. Source - Drain Voltage

# MSM600GS33ALT

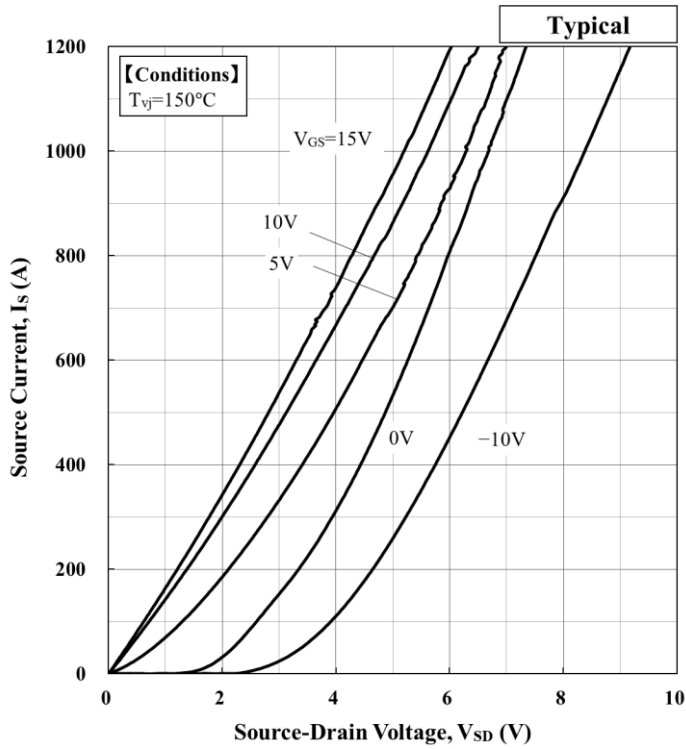

$$V_{SD}[V] = a_3 \cdot |I_S|^3 + a_2 \cdot |I_S|^2 + a_1 \cdot |I_S| + a_0$$

Temp. [°C]	V <sub>GS</sub> [V]	a <sub>3</sub>	a <sub>2</sub>	a <sub>1</sub>	a <sub>0</sub>
150	15	2.62E-10	-1.27E-06	6.19E-03	1.07E-02

Source Current vs. Source - Drain Voltage

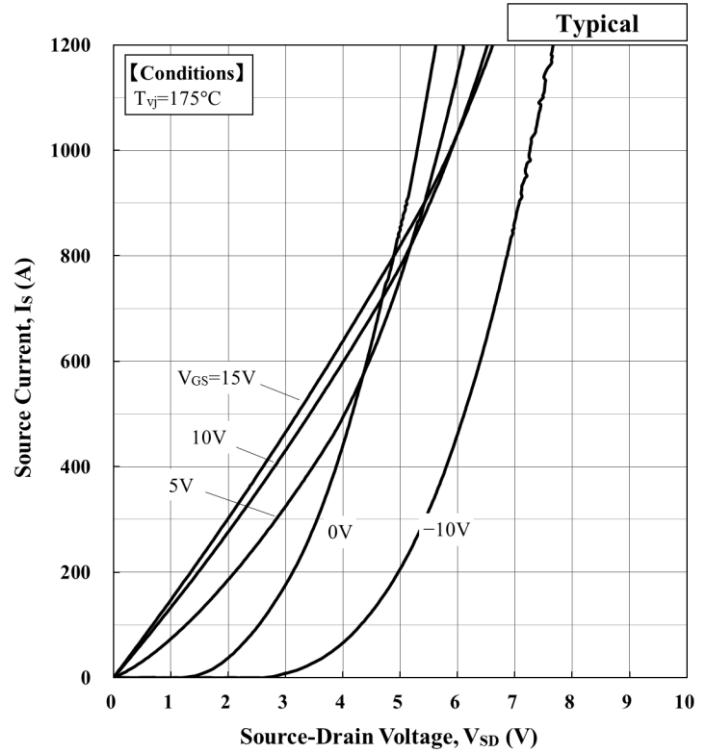

$$V_{SD}[V] = a_3 \cdot |I_S|^3 + a_2 \cdot |I_S|^2 + a_1 \cdot |I_S| + a_0$$

Temp. [°C]	V <sub>GS</sub> [V]	a <sub>3</sub>	a <sub>2</sub>	a <sub>1</sub>	a <sub>0</sub>
175	15	-6.98E-10	-5.31E-08	6.58E-03	2.33E-02

Source Current vs. Source - Drain Voltage

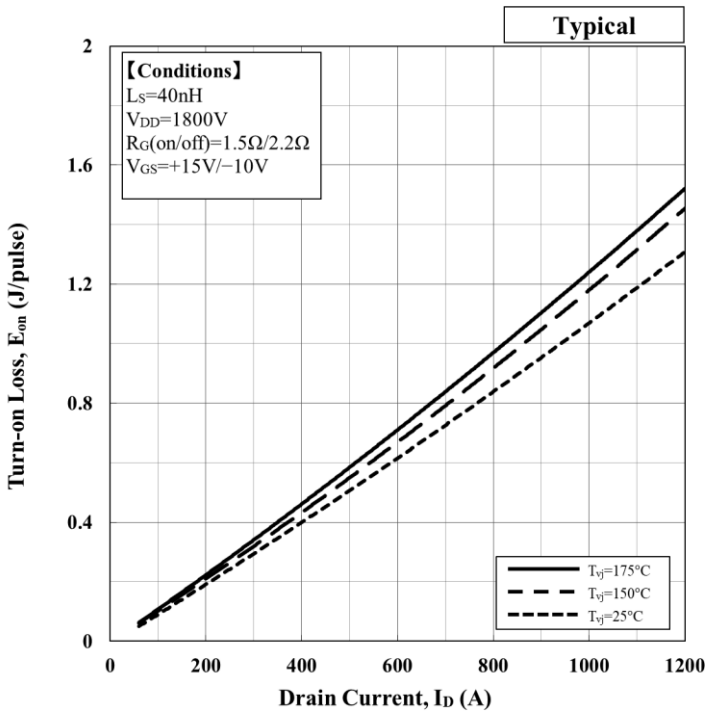

$$E_{on}[J] = a_2 \cdot |I_D|^2 + a_1 \cdot |I_D| + a_0$$

Temp. [°C]	a <sub>2</sub>	a <sub>1</sub>	a <sub>0</sub>
25	9.44E-08	9.84E-04	-9.15E-03
150	1.60E-07	1.02E-03	-8.15E-04
175	1.33E-07	1.11E-03	-4.50E-03

Turn-on loss vs. Drain current

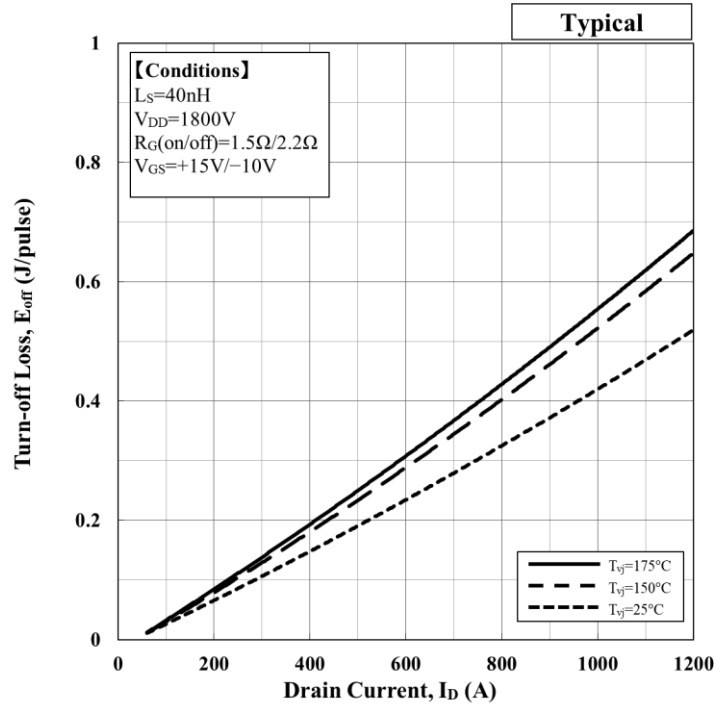

$$E_{off}[J] = a_2 \cdot |I_D|^2 + a_1 \cdot |I_D| + a_0$$

Temp. [°C]	a <sub>2</sub>	a <sub>1</sub>	a <sub>0</sub>
25	5.28E-08	3.79E-04	-1.23E-02
150	7.62E-08	4.63E-04	-1.66E-02
175	7.19E-08	5.01E-04	-1.85E-02

Turn-off loss vs. Drain current

# MSM600GS33ALT

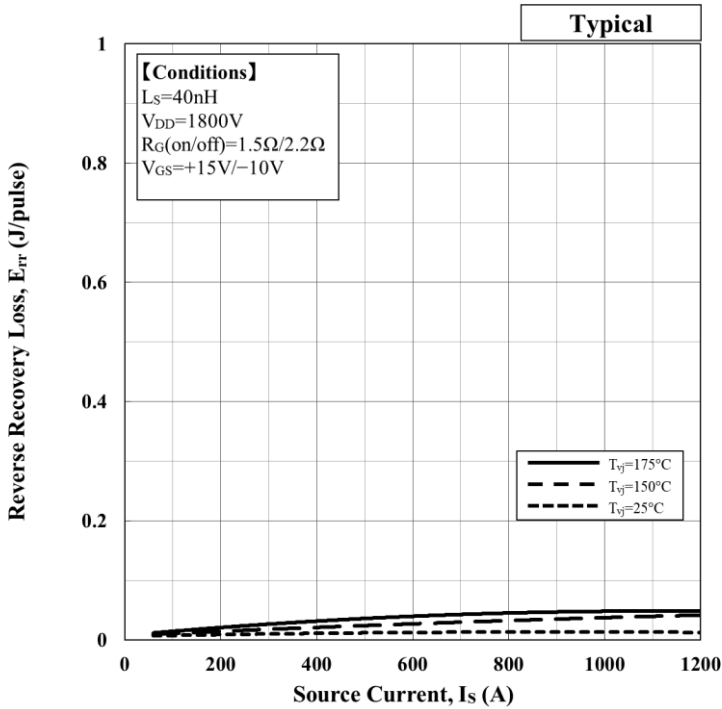

$$E_{rr} [J] = a_2 \cdot |I_s|^2 + a_1 \cdot |I_s| + a_0$$

Temp. [ $^\circ\text{C}$ ]	$a_2$	$a_1$	$a_0$
25	-8.94E-09	1.63E-05	6.06E-03
150	-6.66E-09	3.66E-05	7.49E-03
175	-3.28E-08	7.34E-05	7.51E-03

Recovery loss vs. Source current

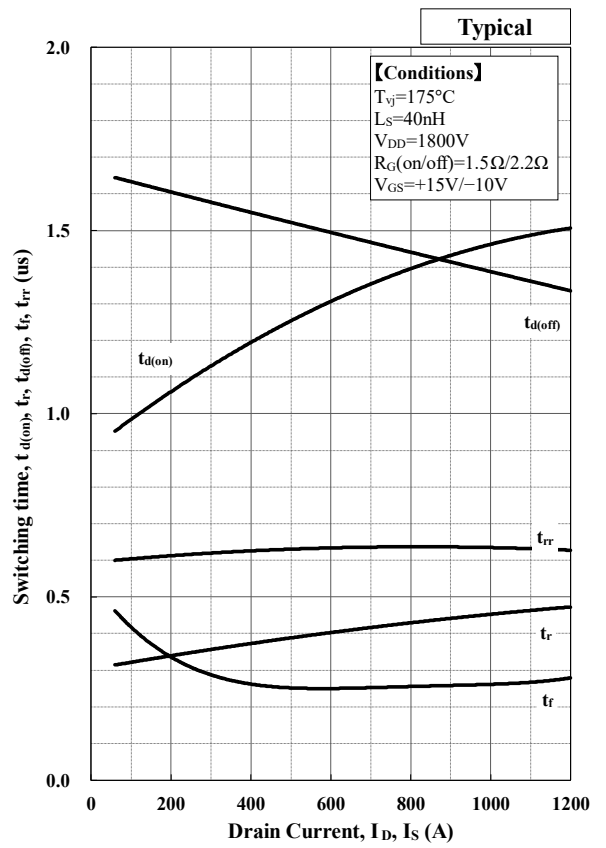

Switching time vs. Drain Current

# MSM600GS33ALT

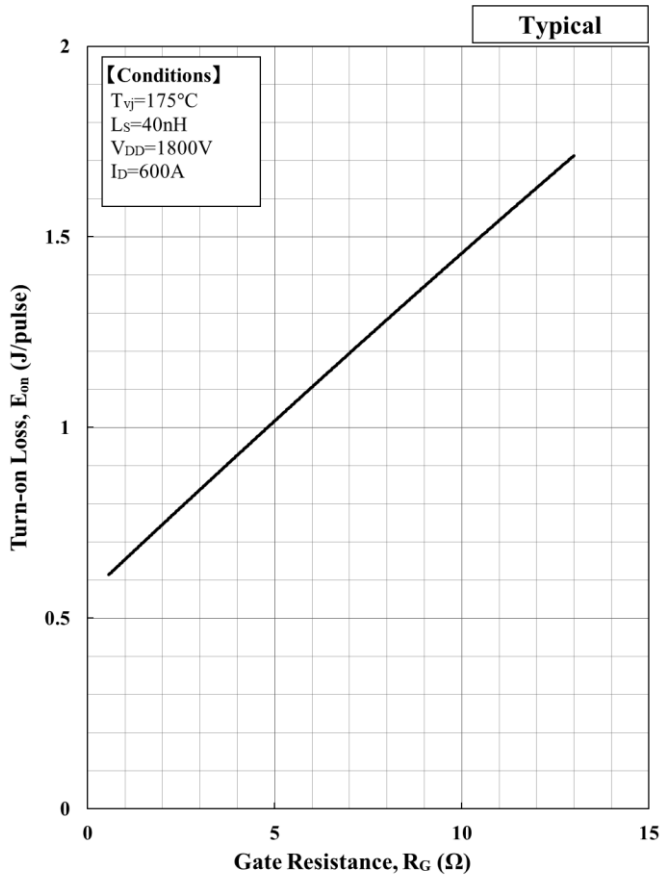

Turn-on loss vs. Gate Resistance

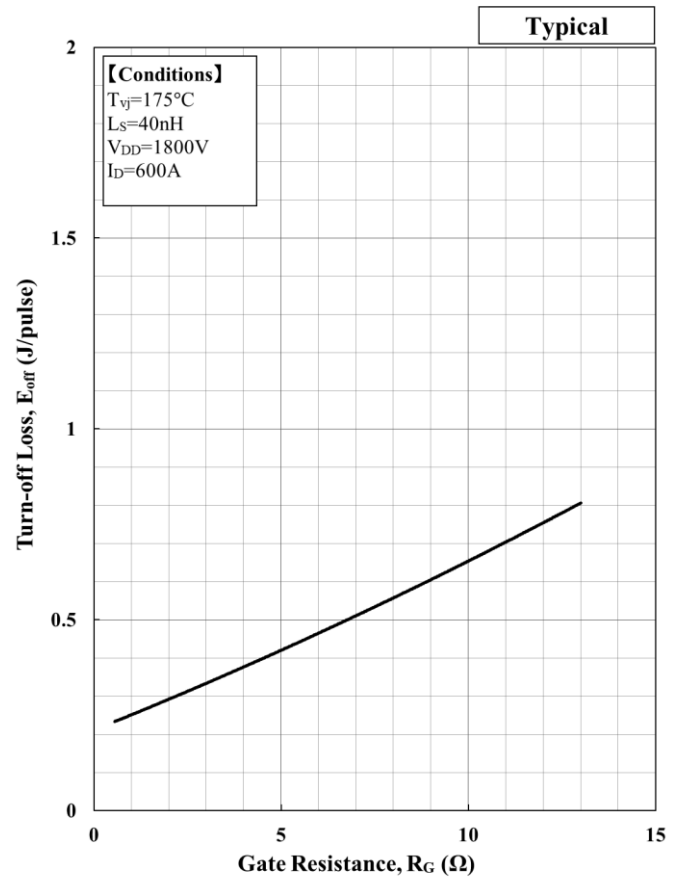

Turn-off loss vs. Gate Resistance

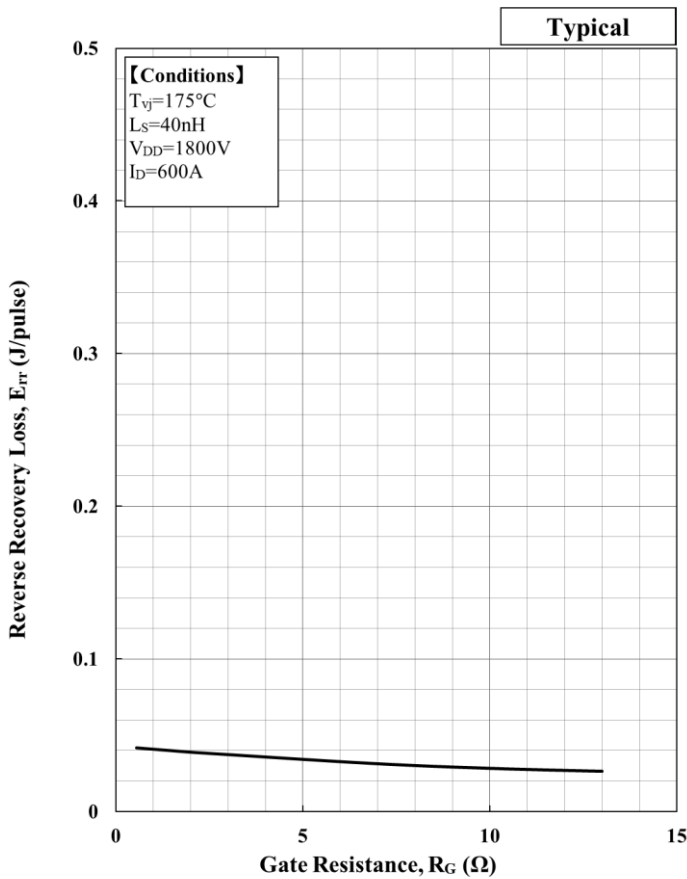

Recovery loss vs. Gate Resistance

# MSM600GS33ALT

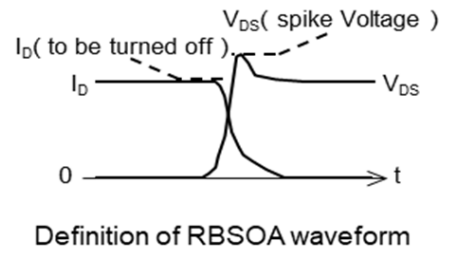
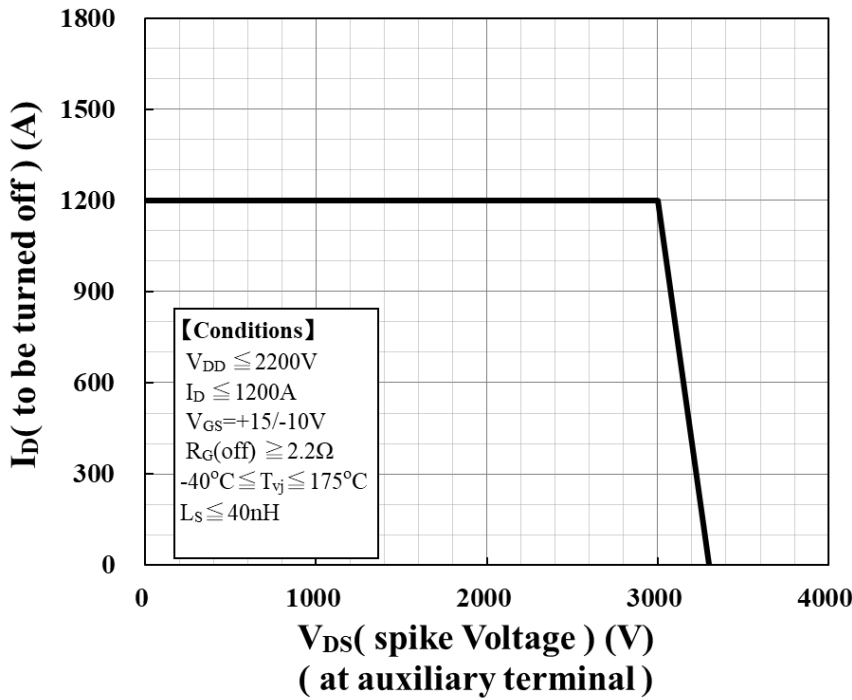

**Reverse Bias Safe Operation Area ( RBSOA )**

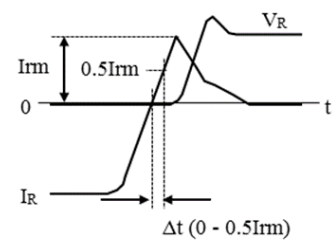
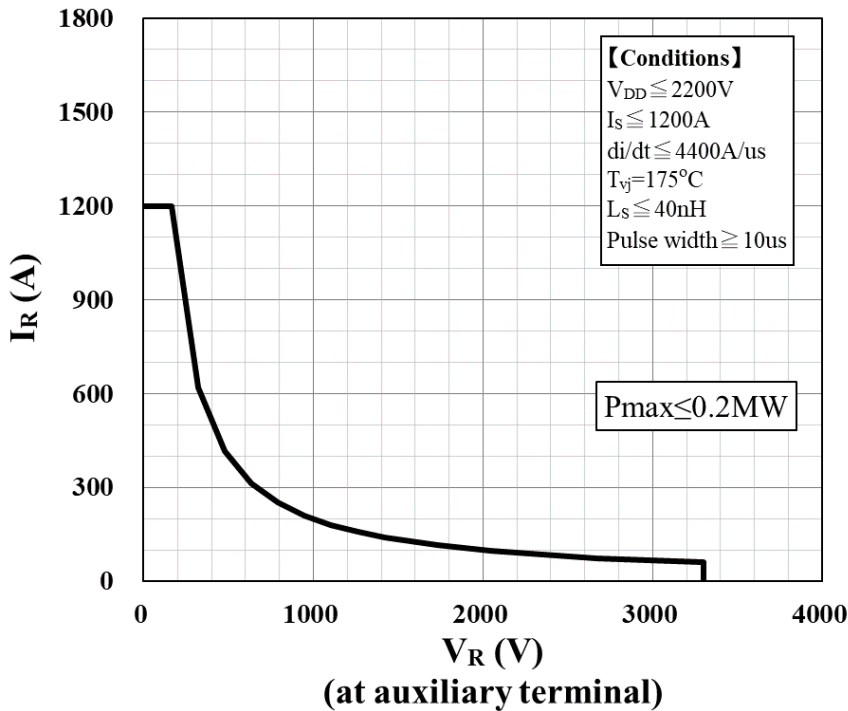

$$di/dt = \frac{0.5I_{rm}}{\Delta t}$$

**Reverse Recovery Safe Operation Area ( RRSOA )**

# MSM600GS33ALT

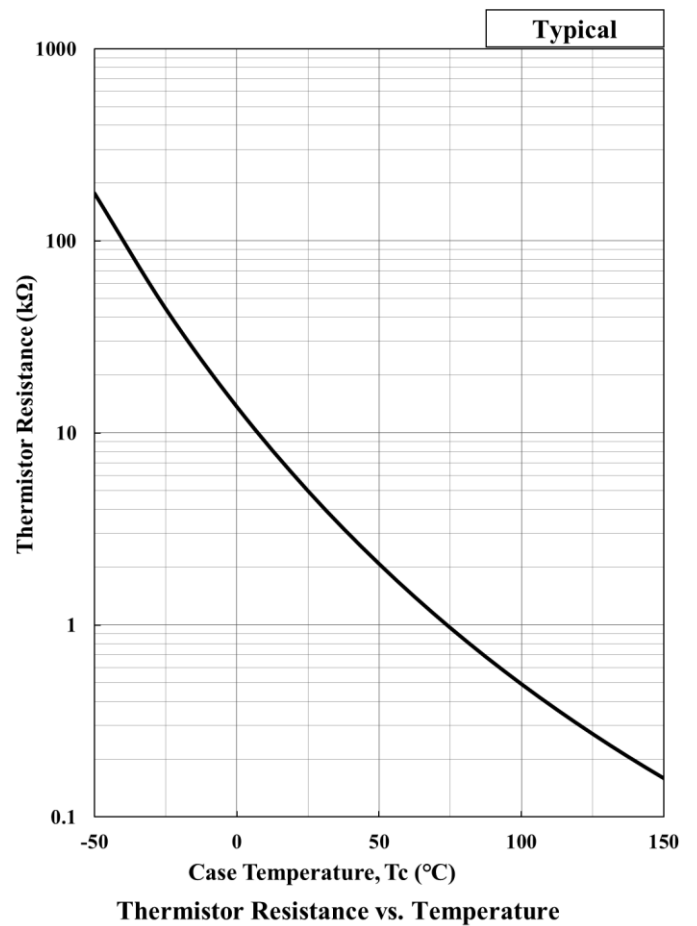
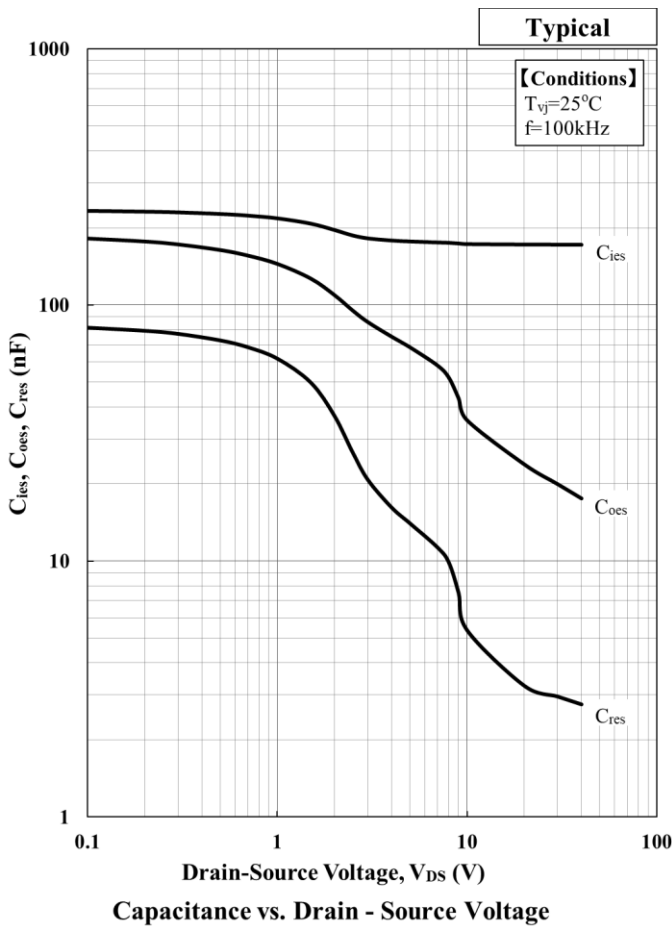
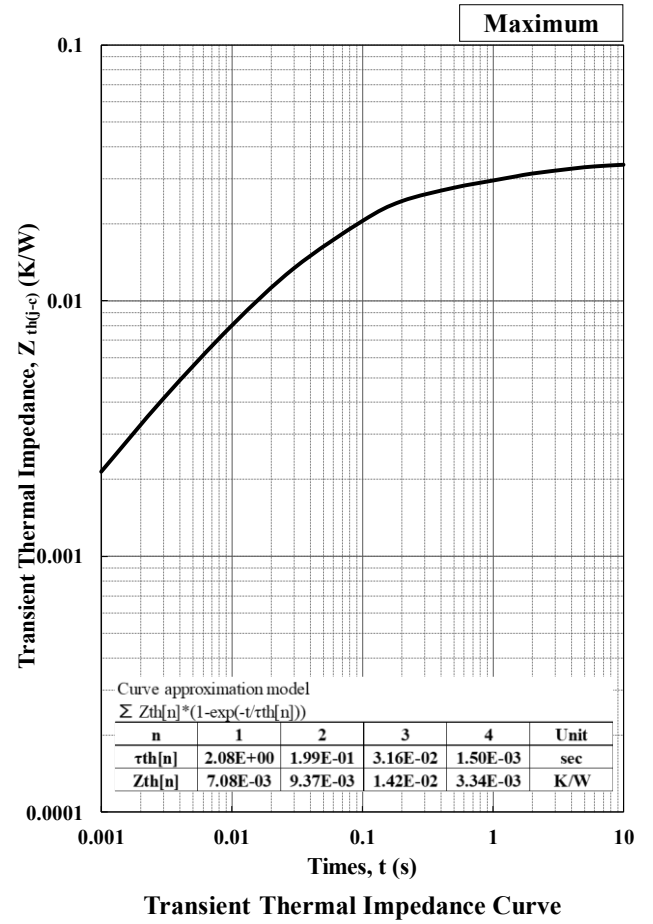
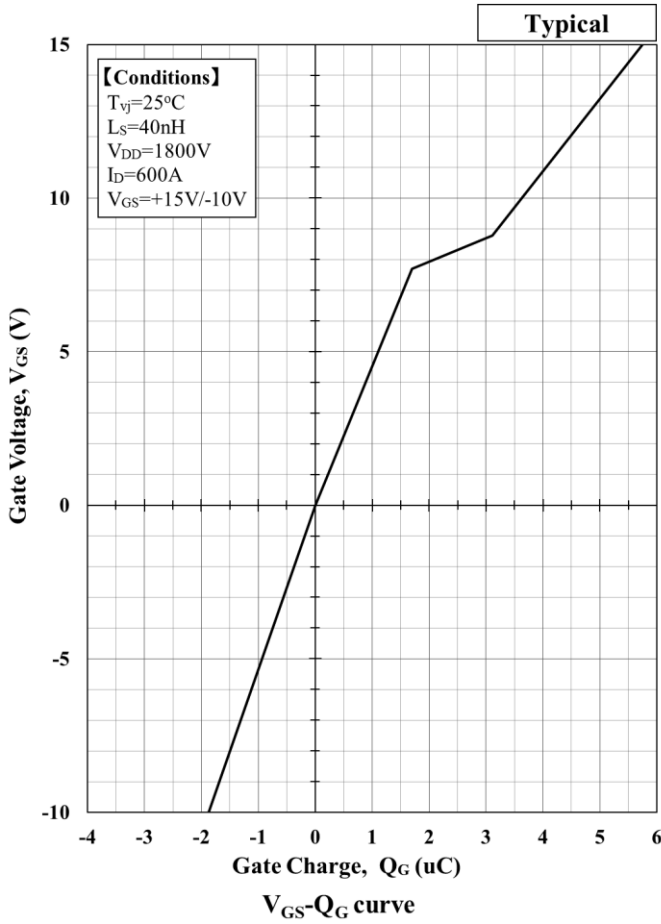



# MSM600GS33ALT

## Minebea POWER SEMICONDUCTORS

### Notices

1. Since mishandling of semiconductor devices may cause malfunctions, please be sure to read "Precautions for Safe Use and Notices" in the individual brochure before use.
2. When designing an electronic circuit using semiconductor devices, please do not exceed the absolute maximum rating specified for the device under any external fluctuations. And for pulse applications, please also do not exceed the "Safe Operating Area (SOA)".
3. Semiconductor devices may sometimes break down by accidental or unexpected surge voltage, so please be careful about the safety design such as redundant design and malfunction prevention design which don't cause the damage expand even if they break down.
4. In cases where extremely high reliability is required (such as use in nuclear power control, aerospace and aviation, traffic equipment, life-support-related medical equipment, fuel control equipment and various kinds of safety equipment), safety should be ensured by using semiconductor devices that feature assured safety or by means of users' fail-safe precautions or other arrangement. Or consult with MPSD's sales department staff. (When semiconductor devices fail, as a result the semiconductor devices or wiring, wiring pattern may smoke, ignite, or the semiconductor devices themselves may burst.)
5. A semi-processed article is done now using solder which contains lead inside the semiconductor devices. There is possibility of the regulation substance depend on the applied models, so please check before using.
6. This specification is a material for component selection, which describes specifications of power semiconductor devices (hereinafter referred to as products), characteristic charts, and external dimension drawings.
7. The information given herein, including the specifications and dimensions, is subject to change without prior notice to improve product characteristics. Before ordering, purchasers are advised to contact with Minebea power semiconductor sales department for the latest version of this data sheets.
8. For handling other than described in this manual, follow the handling instructions (IGBT-HI-00002).

- 
- For inquiries relating to the products, please contact nearest representatives that is located "Inquiry" portion on the top page of a home page.
- 

Minebea power semiconductor home page address

<https://www.minebea-psd.com/>

<https://www.minebea-psd.com/en/>

# MSM600GS33ALT

## Minebea POWER SEMICONDUCTORS

### Usage

1. MPSD warrants that the MPSD products have the specified performance according to the respective specifications at the time of its sale. Testing and other quality control techniques of the MPSD products by MPSD are utilized to the extent MPSD needs to meet the specifications described in this document. Not every device of the MPSD products is specifically tested on all parameters, except those mandated by relevant laws and/or regulations.
2. Following any claim regarding the failure of a product to meet the performance described in this document made within one month of product delivery, all the products in relevant lot(s) shall be re-tested and re-delivered. The MPSD products delivered more than one month before such a claim shall not be counted for such response.
3. MPSD assumes no obligation nor makes any promise of compensation for any fault which should be found in a customer's goods incorporating the products in the market. If a product failure occurs for reasons obviously attributable to MPSD and a claim is made within six months of product delivery, MPSD shall offer free replacement or payment of compensation. The maximum compensation shall be the amount paid for the products, and MPSD shall not assume responsibility for any other compensation.
4. MPSD reserves the right to make changes in this document and to discontinue mass production of the relevant products without notice. Customers are advised to confirm specification of the product of inquiry before purchasing of the products that the customer desired. Customers are further advised to confirm before purchasing of such above products that the product of inquiry is the latest version and that the relevant product is in mass production status if the purchasing of the products by the customer is suspended for one year or more.
5. When you dispose of MPSD products and/or packing materials, comply with the laws and regulations of each country and/or local government. Conduct careful preliminary studies about environmental laws applying to your products such as RoHS, REACH. MPSD shall not assume responsibility for compensation due to contravention of laws and/or regulations.
6. MPSD shall not be held liable in any way for damages and infringement of patent rights, copyright or other intellectual property rights arising from or related to the use of the information, products, and circuits in this document.
7. No license is granted by this document of any patents, copyright or other intellectual property rights of any third party or of MPSD.
8. This document may not be reprinted, reproduced or duplicated, in any form, in whole or in part without the express written permission of MPSD.
9. You shall not use the MPSD products (technologies) described in this document and any other products (technologies) manufactured or developed by using them (hereinafter called "END Products") or supply the MPSD products (technologies) and END Products for the purpose of disturbing international peace and safety, including ( i ) the design, development, production, stockpiling or any use of weapons of mass destruction such as nuclear, chemical or biological weapons or missiles, ( ii ) the other military activities, or ( iii ) any use supporting these activities. You shall not sell, export, dispose of, license, rent, transfer, disclose or otherwise provide the MPSD products (technologies) and END Products to any third party whether directly or indirectly with knowledge or reason to know that the third party or any other party will engage in the activities described above.  
When exporting, re-export transshipping or otherwise transferring the MPSD products (technologies) and END Products, all necessary procedures are to be taken in accordance with Foreign Exchange and Foreign Trade Act (Foreign Exchange Act) of Japan, Export Administration Regulations (EAR) of US, and any other applicable export control laws and regulations promulgated and administered by the governments of the countries asserting jurisdictions over the parties or transaction.